

62048 (EPDM SUPPLIED)
63226 (VITON OPTIONAL)

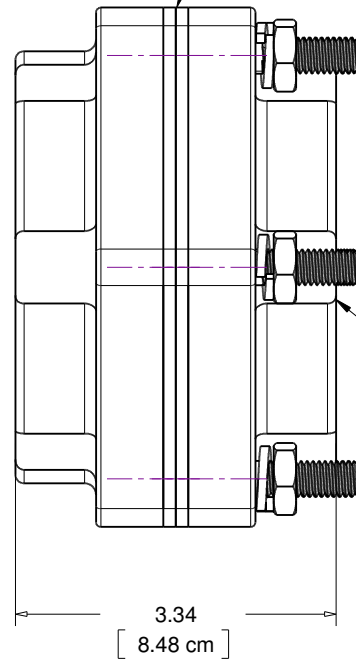

3" NPT
BOTH ENDS

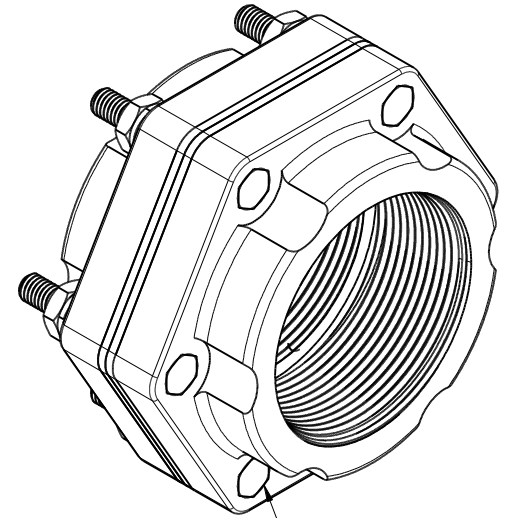

RECESSED
CAP BOLTS

1. MATERIAL - POLYPROPYLENE, EPDM OR VITON GASKET AND 316 SS HARDWARE
2. MAXIMUM TANK WALL = 3/4"
HOLE SAW SIZE = 3"
BOLT DRILL SIZE = 3/8"

BEE VALVE, INC

TITLE/DESC

**3" POLY BOLTED
TANK FITTING**



MATERIAL
SEE MATERIAL
NOTE

THIS DOCUMENT CONTAINS PROPRIETARY INFORMATION AND MAY NOT BE DISCLOSED TO OTHERS FOR ANY PURPOSE, NOR USED FOR MANUFACTURING PURPOSES WITHOUT THE WRITTEN PERMISSION OF BEE VALVE INC

DATE
09/11/17

PART NO
300-TFC

REV
09/21/17